

0.050 FC

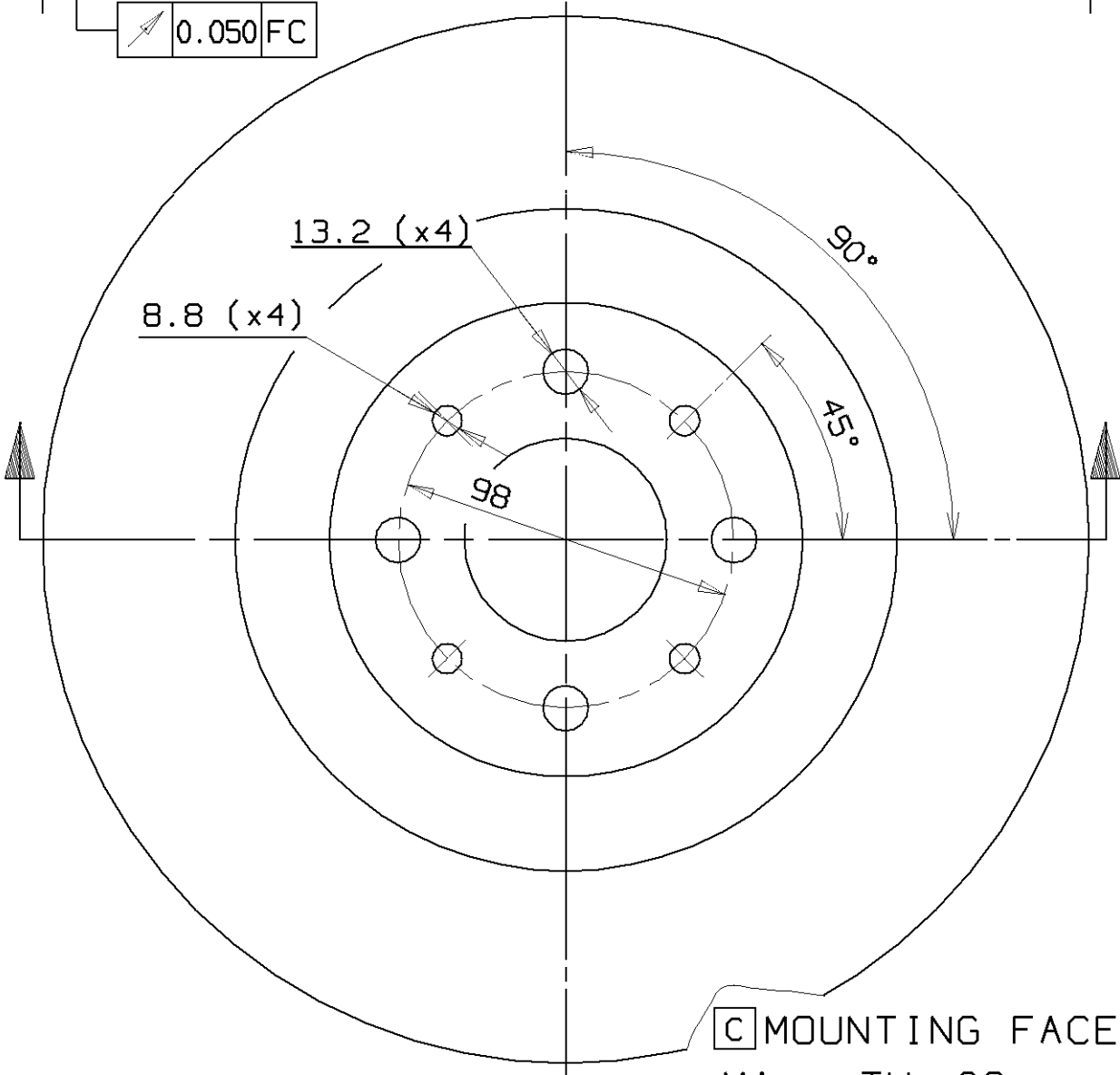

C MOUNTING FACE
 Min. TH 26 mm
 Weight 7.6 Kg

Type DA